

SIGN KEY

- (A) Antennae Signs
- (V) Vacuum Signs
- (E) Exterior
- (M) Menu
- (G) Gate Signs
- (P) Pole Sign
- (T) Tunnel
- (F) A-Frame
- (C) Column
- (X) XPT Back
- (W) Window Signs
- (L) Exterior Lettering
- (B) Monument Sign

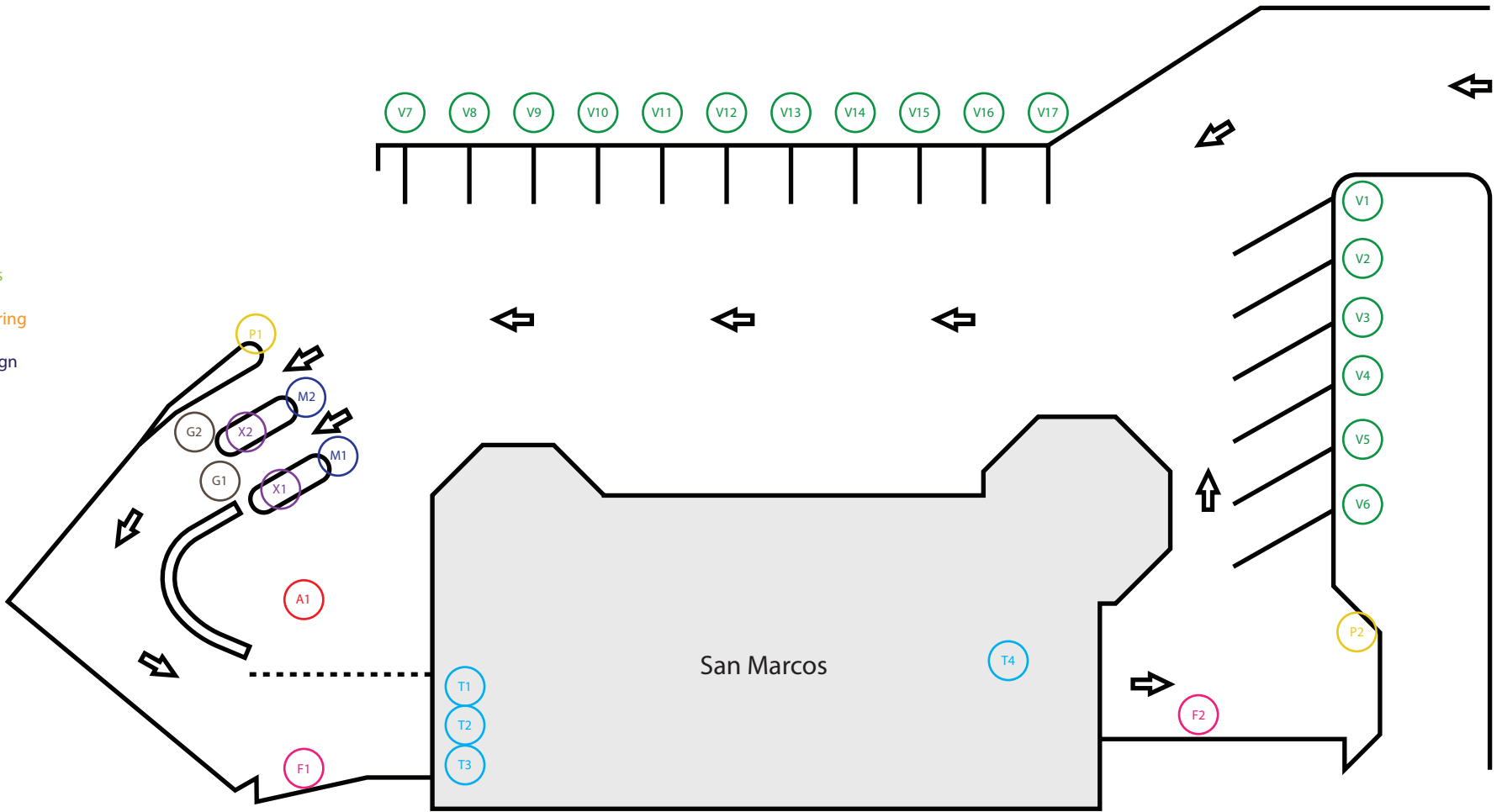

SIGN KEY

- Ⓐ Antennae Signs
- Ⓥ Vacuum Signs
- Ⓔ Exterior
- Ⓜ Menu
- Ⓖ Gate Signs
- Ⓟ Pole Sign
- Ⓣ Tunnel
- Ⓕ A-Frame
- Ⓒ Column
- Ⓧ XPT Back
- Ⓦ Window Signs
- Ⓛ Exterior Lettering
- Ⓑ Monument Sign

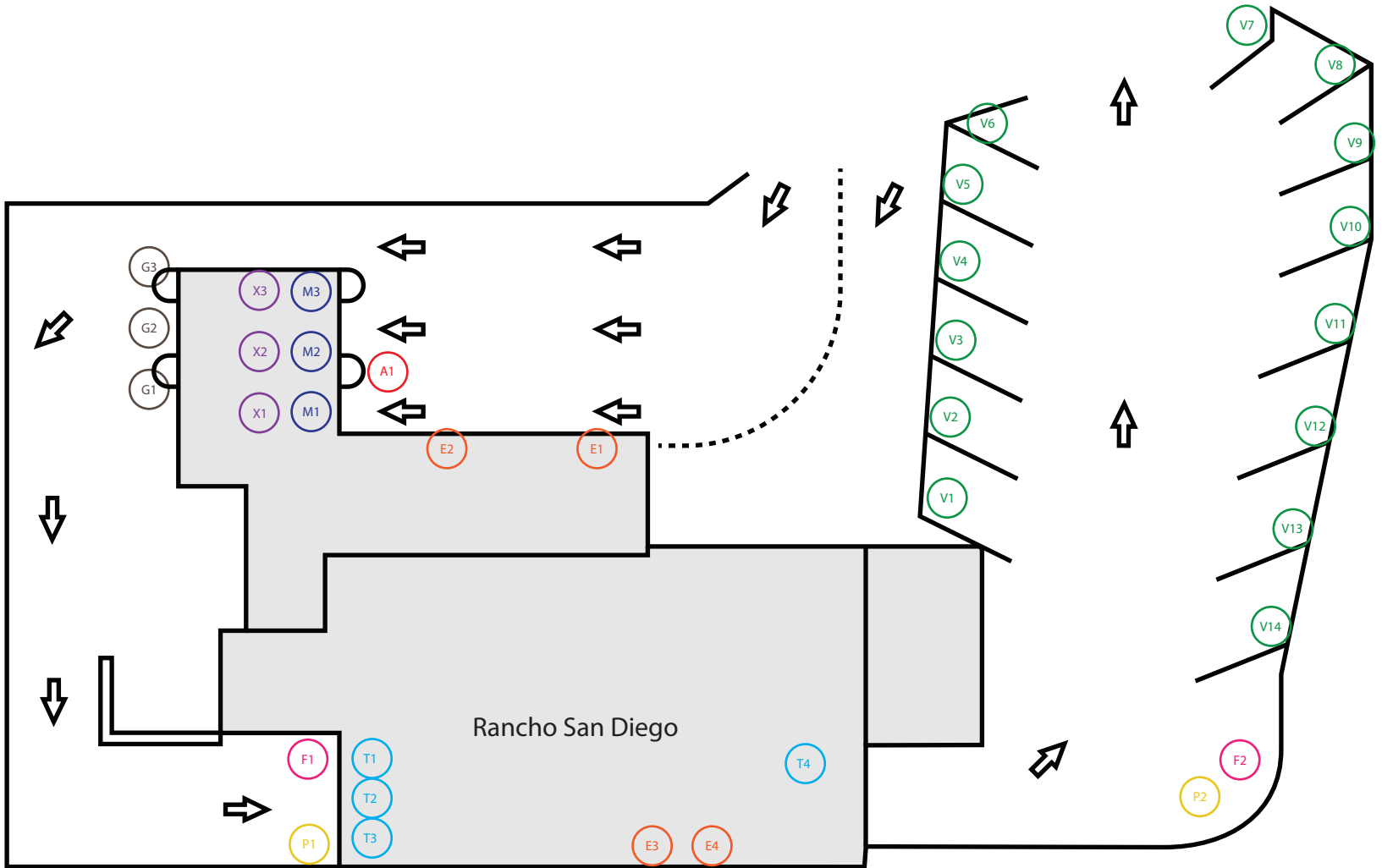

SIGN KEY

- (A) Antennae Signs
- (V) Vacuum Signs
- (E) Exterior
- (M) Menu
- (G) Gate Signs
- (P) Pole Sign
- (T) Tunnel
- (F) A-Frame
- (C) Column
- (X) XPT Back
- (W) Window Signs
- (L) Exterior Lettering
- (B) Monument Sign

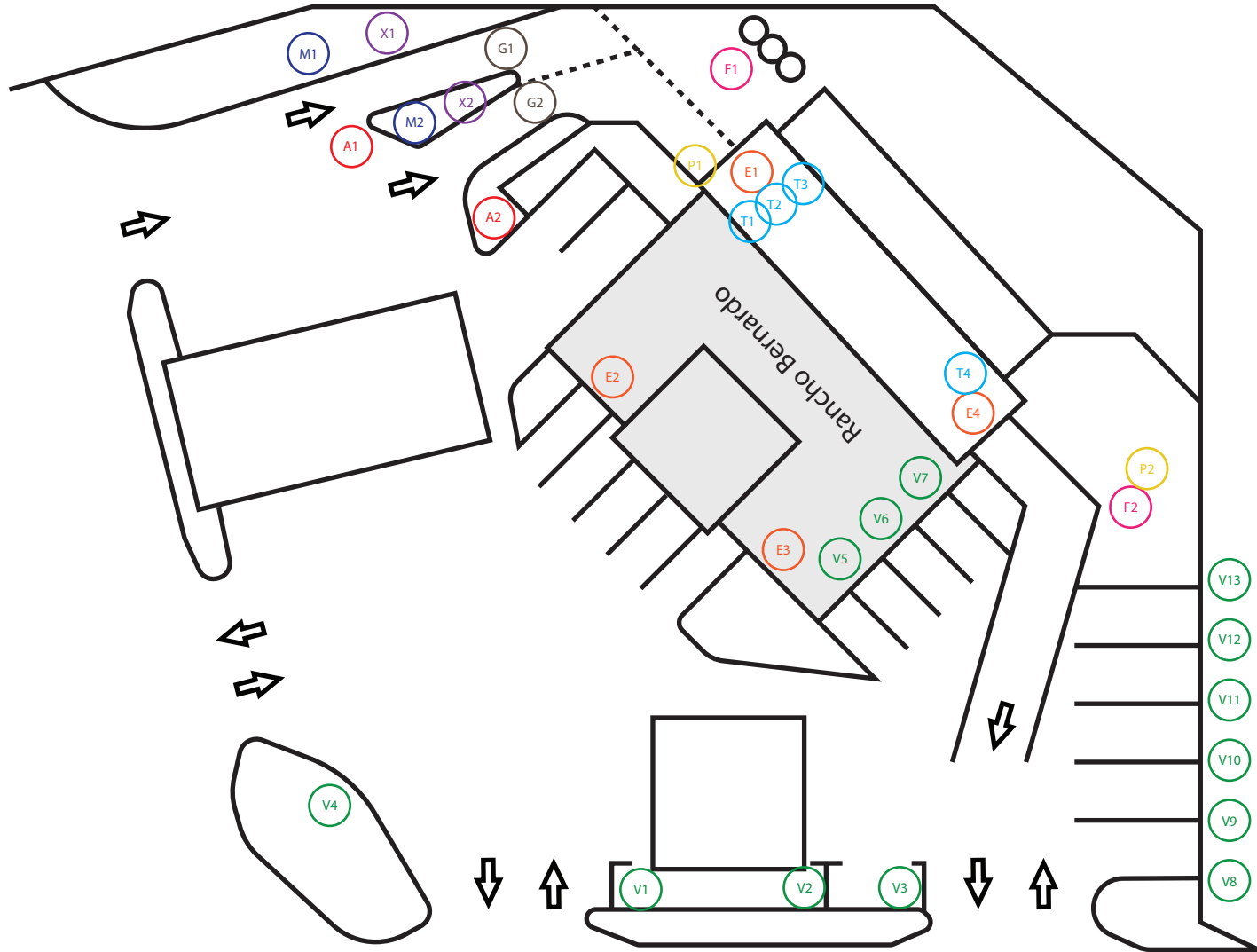

SIGN KEY

- (A) Antennae Signs
- (V) Vacuum Signs
- (E) Exterior
- (M) Menu
- (G) Gate Signs
- (P) Pump Topper
- (T) Tunnel
- (F) A-Frame
- (C) Column
- (X) XPT Back
- (W) Window Signs
- (P) Pole Sign
- (L) Exterior Lettering
- (B) Monument Sign

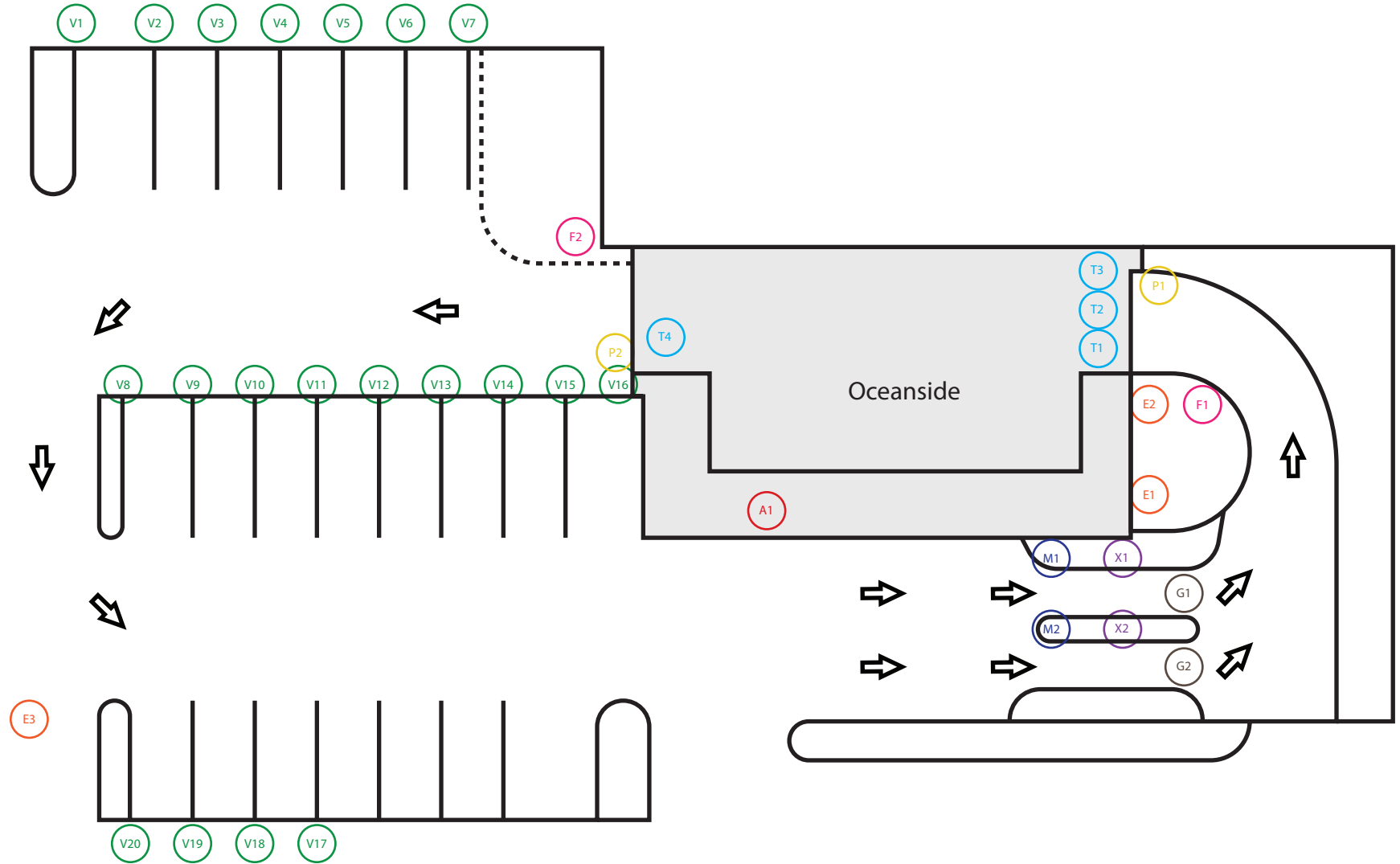

SIGN KEY

- (A) Antennae Signs
- (V) Vacuum Signs
- (E) Exterior
- (M) Menu
- (G) Gate Signs
- (P) Pole Sign
- (T) Tunnel
- (F) A-Frame
- (C) Column
- (X) XPT Back
- (W) Window Signs
- (L) Exterior Lettering
- (B) Monument Sign

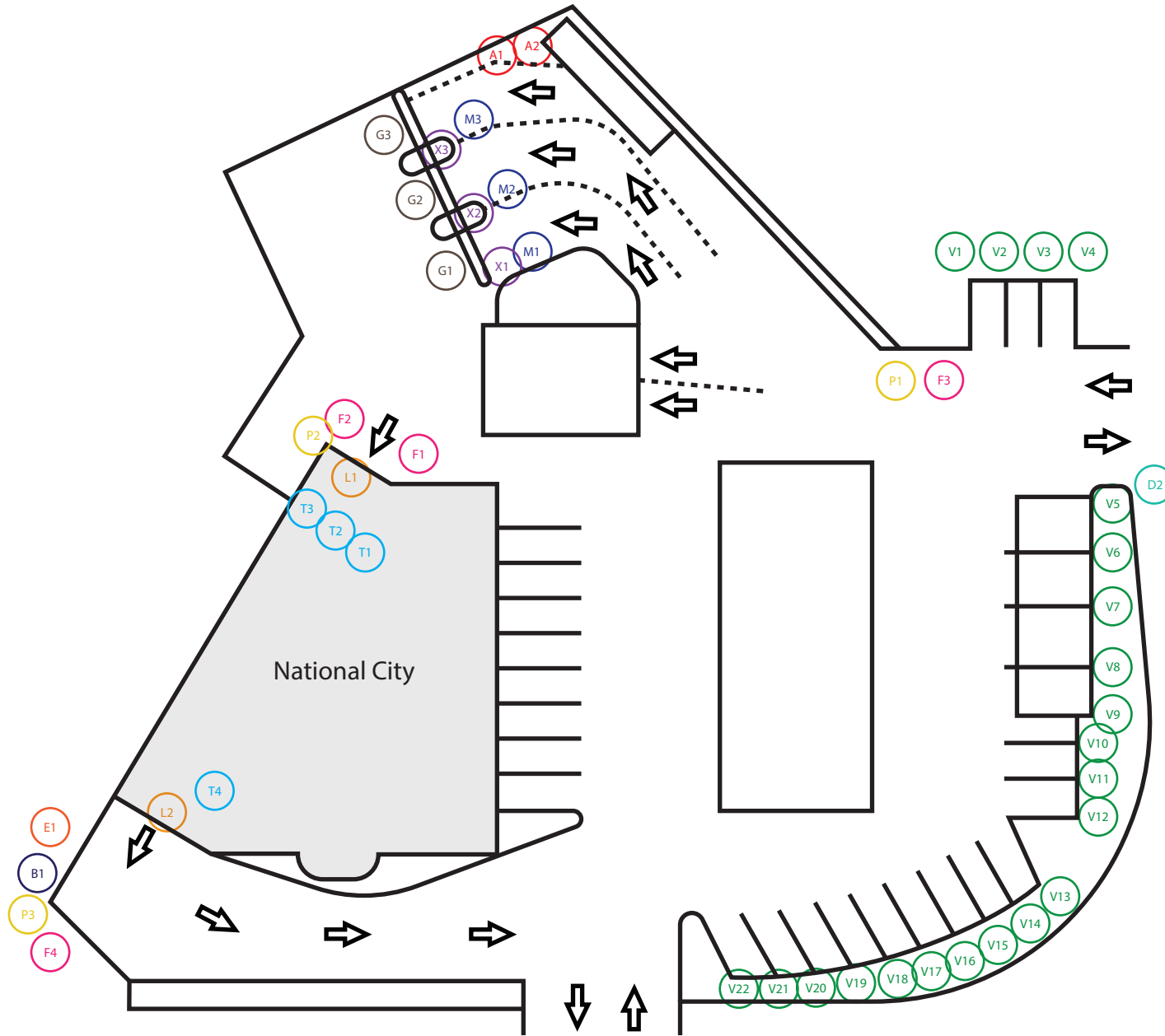

SIGN KEY

- (A) Antennae Signs
- (V) Vacuum Signs
- (E) Exterior
- (M) Menu
- (G) Gate Signs
- (P) Pole Sign
- (T) Tunnel
- (F) A-Frame
- (C) Column
- (X) XPT Back
- (W) Window Signs
- (L) Exterior Lettering
- (B) Monument Sign

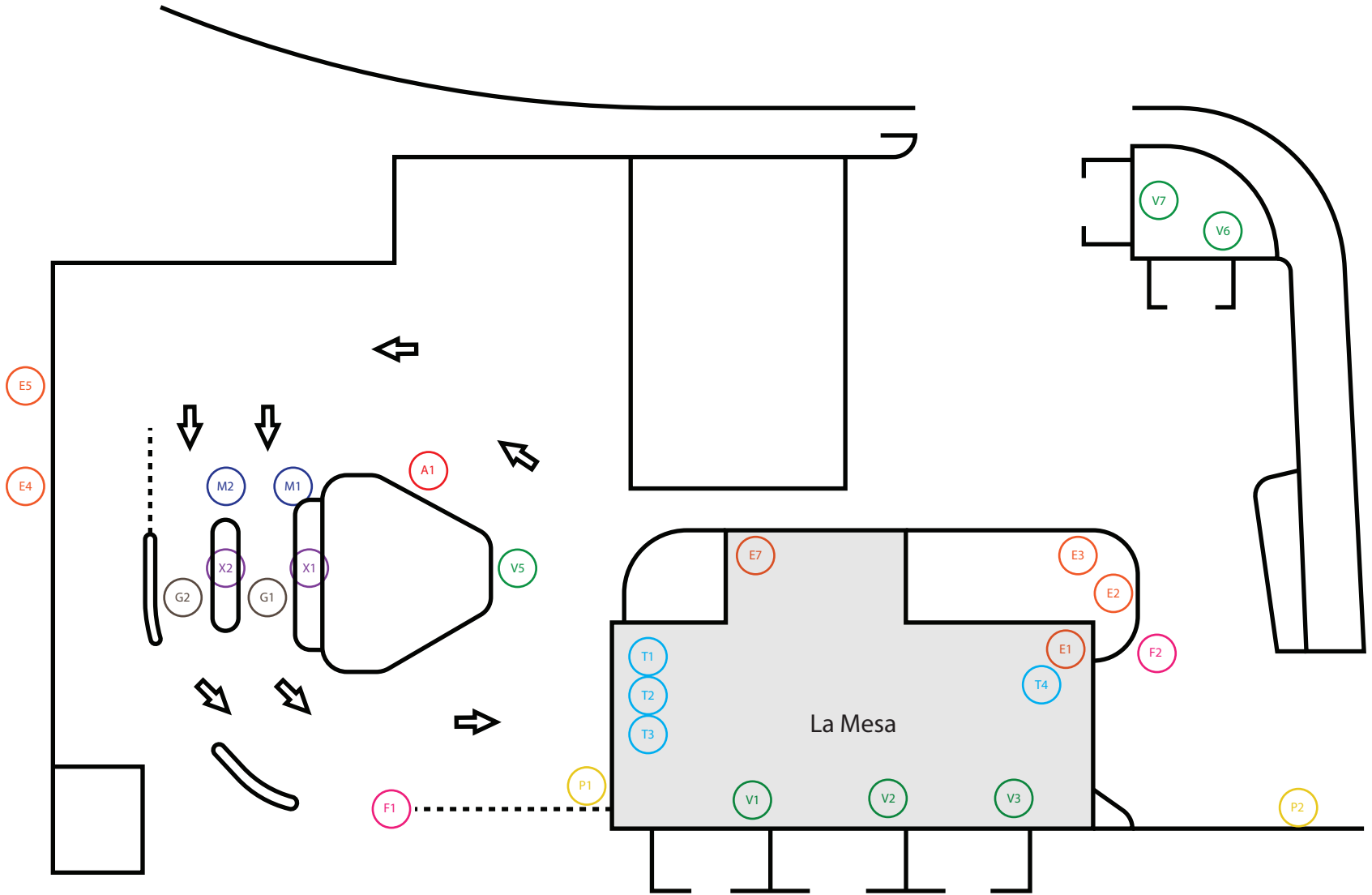

SIGN KEY

- (A) Antennae Signs
- (V) Vacuum Signs
- (E) Exterior
- (M) Menu
- (G) Gate Signs
- (P) Pole Sign
- (T) Tunnel
- (F) A-Frame
- (C) Column
- (X) XPT Back
- (W) Window Signs
- (L) Exterior Lettering
- (B) Monument Sign

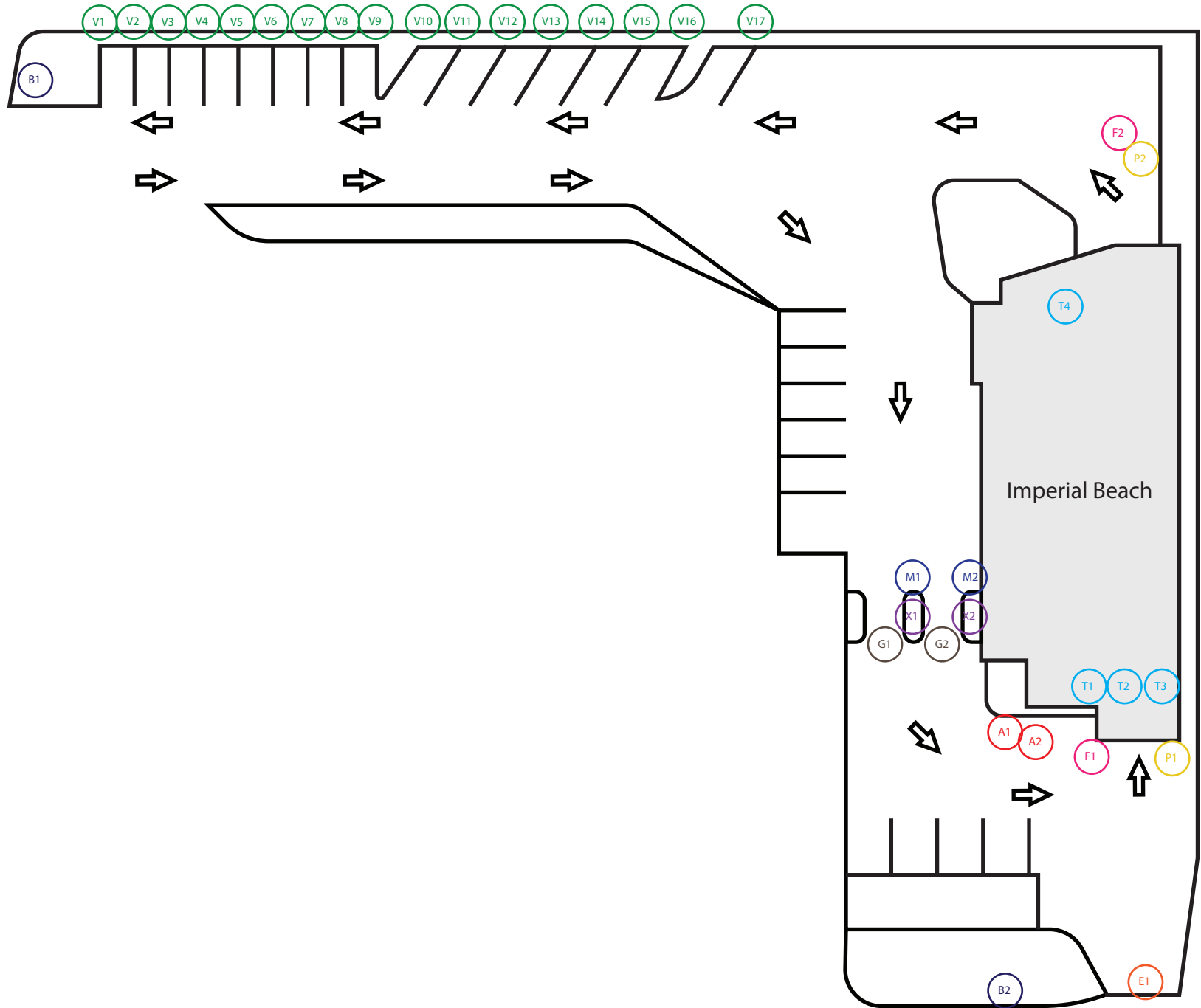

SIGN KEY

- Ⓐ Antennae Signs
- Ⓥ Vacuum Signs
- Ⓔ Exterior
- Ⓜ Menu
- Ⓖ Gate Signs
- Ⓟ Pump Topper
- Ⓣ Tunnel
- Ⓕ A-Frame
- Ⓒ Column
- ⓧ XPT Back
- Ⓦ Window Signs
- Ⓟ Pole Sign
- Ⓛ Exterior Lettering
- Ⓑ Monument Sign

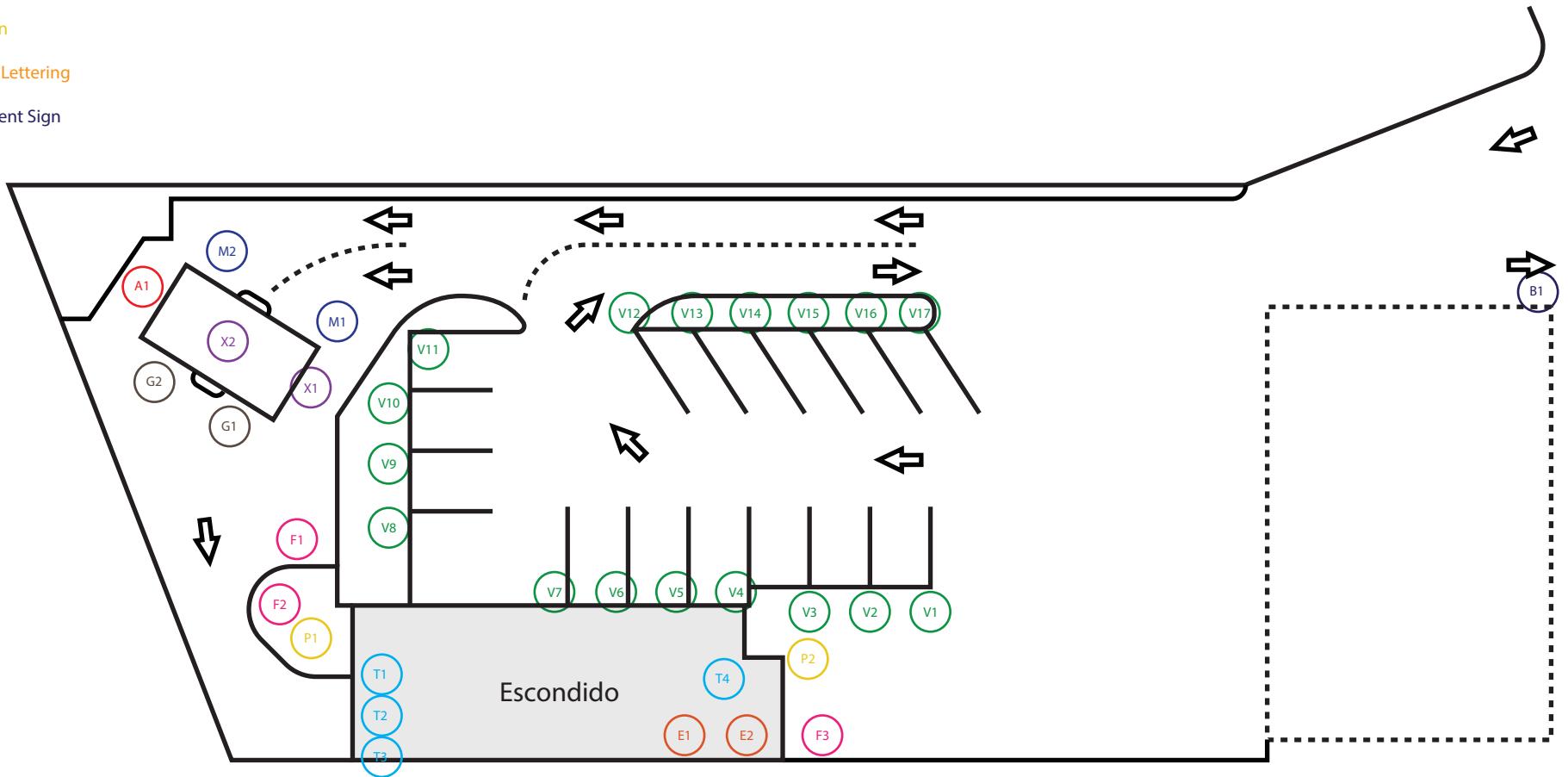



SIGN KEY

- (A) Antennae Signs
- (V) Vacuum Signs
- (E) Exterior
- (M) Menu
- (G) Gate Signs
- (P) Pole Sign
- (T) Tunnel
- (F) A-Frame
- (C) Column
- (X) XPT Back
- (W) Window Signs
- (L) Exterior Lettering
- (B) Monument Sign

